

VINTEC

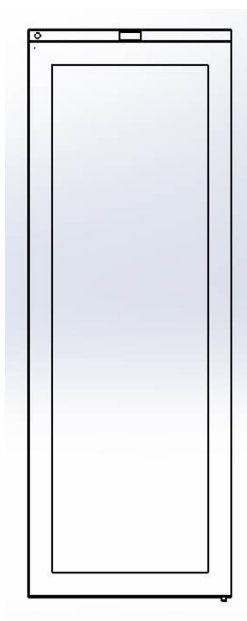

V300SGe mono zone / V300SG2e multi zone wine cellar

GB Instruction for use

Warning.

In case this appliance contains hydrocarbon refrigerant please refer to guidelines listed below.

As the appliance contains a flammable refrigerant, it is essential to ensure that the refrigerant pipes are not damaged.

Standard EN378 specifies that the room in which you install your appliance must have a volume of 1m³ per 8 g of hydrocarbon refrigerant used in the appliances. This is to avoid the formation of flammable gas/ air mixtures in the room where the appliance is located in the event of a leak in the refrigerant circuit. The quantity of the refrigerant used in your appliance is indicated on the rating plate.

WARNING: Keep ventilation openings in the appliance's cabinet or in the built-in structure clear of obstruction

WARNING: Do not use other **mechanical devices** or other means to accelerate the defrosting process than those recommended by the manufacturer

WARNING: Do not damage the refrigerant system

WARNING: Do not use **electrical appliances** inside the refrigerated storage compartment, unless they are of a type recommended by the manufacturer

WARNING: Do not expose the appliance to rain

WARNING: This appliance is not intended for use by young children or infirm persons unless they have been adequately supervised by a responsible person to ensure that they can use the appliance safely. Young children should be supervised to ensure that they do not play with the appliance

- Always keep the keys in a separate place and out of reach of children
- Before servicing or cleaning the appliance, unplug the appliance from the mains or disconnect the electrical power supply
- If the supply cord is damaged, it must be replaced by the manufacturer, its service agent, or similarly qualified persons in order to avoid a hazard
- **Relevant for Australia:** Supply cord fitted with a plug complies with AS/NZS 3112.
- Frost formation on the interior evaporator wall and upper parts is a natural phenomenon. Therefore, the appliance should be defrosted during normal cleaning or maintenance
- Please note that changes to the appliance construction will cancel all warranty and product liability
- This appliance is intended to be used exclusively for the storage of wine

CLASS 1 LED PRODUCT

Get to know your wine cellar

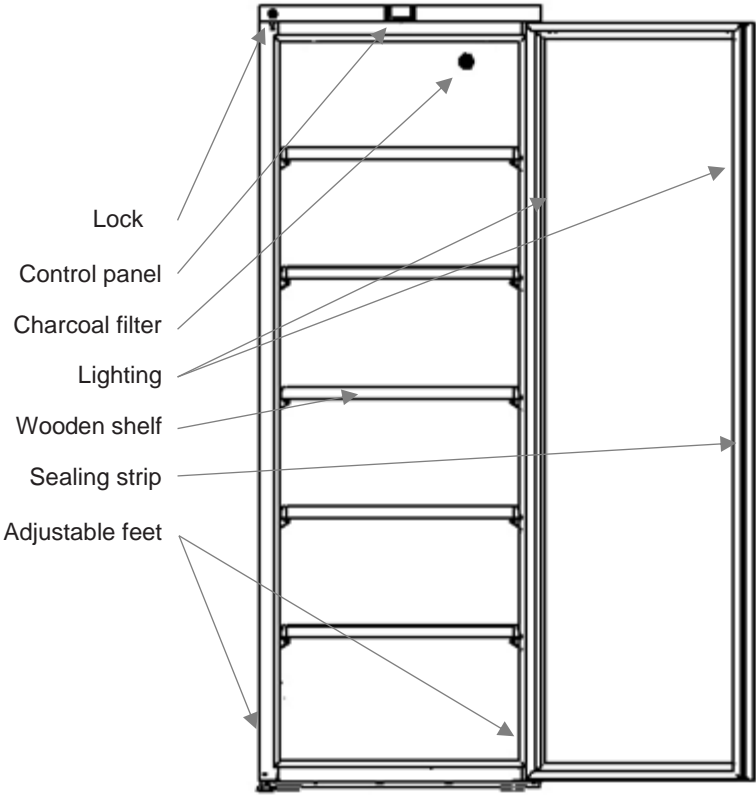

Contents

Warning	2
Get to know your wine cellar	3
Before use	4
Installation and start-up	4
Technical data	6
Operation and function V300SGe mono zone wine cellar.....	7
Fault finding of V300SGe mono zone wine cellar	10
Operation and function V300SG2e multi zone wine cellar	11
Fault finding of V300SG2e multi zone wine cellar	13
Defrosting, cleaning and maintenance.....	14
Warranty, spare parts and service ..	15

Before use

On receipt, check to ensure that the appliance has not been damaged during transport. Transport damage should be reported to the local distributor before the wine cellar is put to use.

Remove the packaging. Clean the inside of the cabinet using warm water with a mild detergent. Rinse with clean water and dry thoroughly (see cleaning instructions). Use a soft cloth.

If during transport the appliance has been laid down, or if it has been stored in cold surroundings (colder than +5°C), it must be allowed to stabilise in

Installation and start-up

an upright position for at least an hour before being switched on

Placement

For safety and operational reasons, the appliance must not be installed outdoors.

The appliance should be placed on a level surface in a dry, well ventilated room. Never place the appliance close to sources of heat such as cookers or radiators, and avoid placing it in direct sunlight.

Ambient temperature

The climate class is stated on the nameplate. This specifies the optimum ambient temperature. Wine cellars with winter position, however, function at ambient temperatures as low as 6°C

Climate class	Optimum room temperature
SN	+10 °C to +32 °C
N	+16 °C to +32 °C
ST	+18 °C to +38 °C
T	+18 °C to +43 °C

Installation

The surface on which the appliance is to be placed must be level. Do not use a frame or similar.

The appliance can be installed as a free-standing unit against a wall, built into a kitchen element, or lined up with other appliances (figs 2-3).

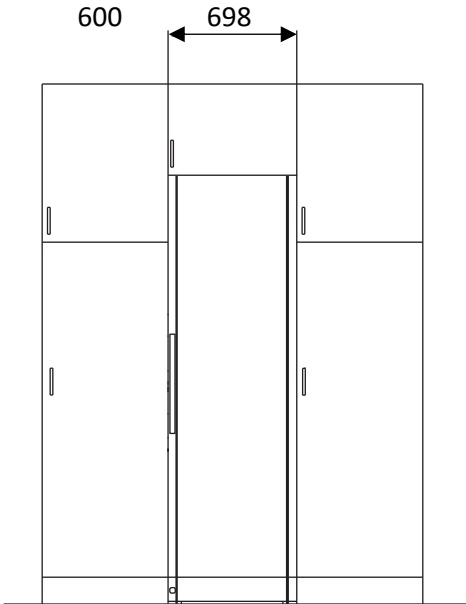

fig. 2

The appliance viewed from above

If the appliance is placed beside a wall, there must be sufficient room for its door to be opened wide enough to allow the shelves to be pulled out (fig. 4).

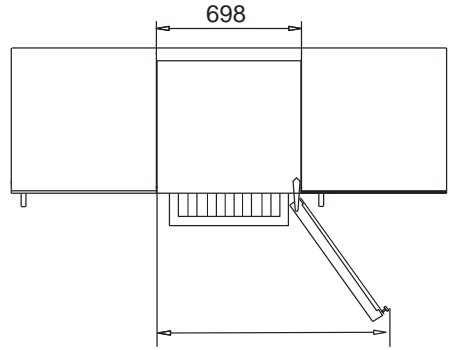

fig. 4

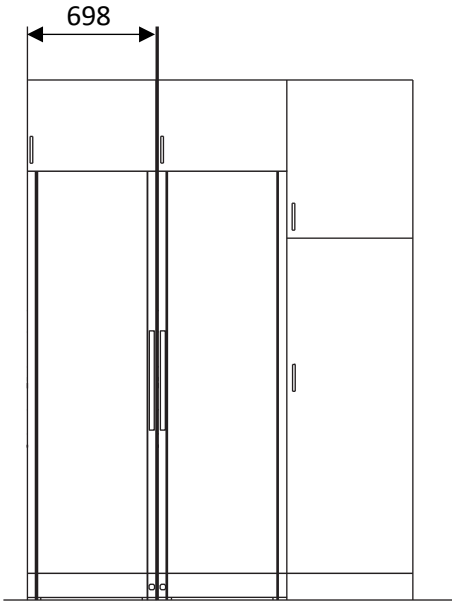

fig. 3

Ventilation

It is important that the appliance be well ventilated and that air can circulate unhindered above, below and around it. The figures below illustrate how the necessary air circulation around the appliance can be ensured (figs 5-6).

fig.5

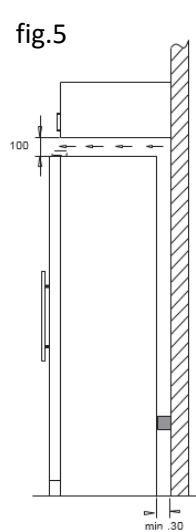
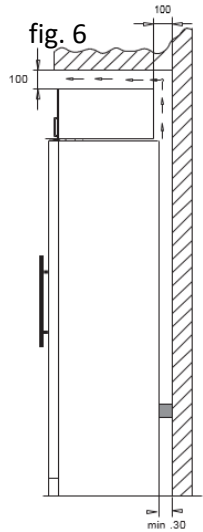

fig. 6



Setting up

It is important that the appliance be absolutely level. It can be levelled by screwing the adjustable feet at the front of the appliance up or down (figs 7). Use a spirit level to check that the appliance is absolutely level sideways.

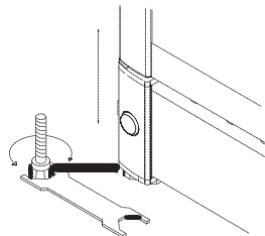
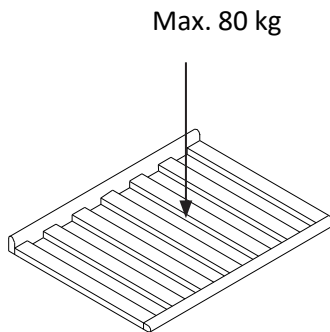

fig. 7

Technical data

This device complies with relevant EU directives including Low Voltage Directive 2006/95 EEC and Electromagnetic Compatibility Directive 2004/108/EC

The rating plate provides various technical information as well as type and serial number.



Operation and function V300SGe mono zone wine cellar



Electronic control

The electronic control ensures that the temperatures set. This is achieved by means of an advanced control of the refrigeration system. The set temperature will be stored in the event of power failure.

The electronic control has the following functions:



- On/off switch
- Light switch
- Temperature setting
- Temperature indication
- Alarm for too high and too low temperatures



Temperature indication

The display shows the set temperature.

Temperature setting



The controller is equipped with a child lock device. This device is activated by pushing

the “up”  and “down”  buttons simultaneously. After approx. 3 seconds “Pof” flashes in the display.

The child lock device is cancelled by pushing the  and  buttons simultaneously. After approx. 3 seconds “Pon” flashes in the display, and the temperature can be set.

For the temperature setting push SET key for more than 2 seconds.

The value of the set point will be displayed and the “°C” or “°F” LED starts blinking;

To change the Set value push the  or  arrows within 10s.

The set temperature can be between 10 and 14°C.

To memorise the new set point value push the SET key again or wait 10s.

Alarm devices

There is a sub-alarm for the high-temperature sensor. 

The alarm consists of a warning on the display.

Alarm for high temperature: alternating display of "HA" and actual temperature

Alarm for low temperature: alternating display of "LA" and actual temperature

The alarm temperature depends on the set points.

Temperature alarms automatically stop as soon as the temperature returns to normal values.

Winter function

If the temperature goes under 4°C in the cabinet, the heating element will be activated until the inside temperature reaches the 7°C.

Light

To turn on/off the lights, press once 
If the LED lights are switched on these will be switched off automatically after 15 minutes.

Long-term storage

For long-term wine storage the temperature should be set at 12°C.

However, the temperature in the room will gradually affect the temperature in the cabinet through its door and sides, creating a slight temperature gradient from top to bottom. The controls will maintain the set temperature at the bottom of the cabinet, and any deviation from the setting will therefore occur at the top.

The difference will vary from 0 to 3°C, depending on the ambient temperature.

Fault finding of V300SGe mono zone wine cellar

Fault	Possible cause	Remedy
The appliance not working	<p>The appliance is switched off.</p> <p>Power failure; the fuse is blown; the appliance is not plugged in correctly.</p>	<p>Press the on/off switch.</p> <p>Check that power is connected. Reset the fuse.</p>
Water collects in the bottom of the cabinet.	The defrost water pipe is blocked.	Clean the defrost water channel and the drain hole on the rear wall of the cabinet.
Vibration or bothersome noise.	<p>The appliance is not level.</p> <p>The appliance is resting against other kitchen elements.</p> <p>Containers or bottles inside the cabinet are rattling against one another.</p>	<p>Level the appliance using a spirit level.</p> <p>Move the appliance away from the kitchen elements or appliances it is in contact with. Move containers and/or bottles apart.</p>
Compressor runs continuously.	High room temperature.	Ensure adequate ventilation.
P1 is shown on the display.	The sensor is disconnected or short-circuited.	Call for service. The temperature within the entire cabinet is maintained at the higher of the two setpoints until the fault has been corrected.

Operation and function of V300SG2e multi zone wine cellar



Electronic control

The electronic control ensures that the temperatures set at the top and at the bottom of the appliance are maintained. This is achieved by means of an advanced control of the refrigeration system, the heating element. The set temperature will be stored in the event of power failure.

The electronic control has the following functions:

- On/off switch
- Light switch
- Temperature setting
- Temperature indication
- Alarm for too high and too low temperatures

Temperature indication

The display shows the set temperatures. The upper digits of the display indicate the set temperature at the top of the appliance, and the lower digits of the display indicate the set temperature at the bottom of the appliance.

Temperature setting

The thermostat is equipped with a child lock device. This device is activated by pushing the “up and down” buttons simultaneously. After approx. 3 seconds “Pof” flashes in the display. Then the actual temperatures are shown as usual. In addition, the set temperatures can be shown by pushing SET1 and SET2, respectively.

The child lock device is cancelled by pushing the “up and down” buttons simultaneously. After approx. 3 seconds “Pon” flashes in the display, and the temperature can be set.

Temperature setting at the top of the appliance

Push SET1. Then the temperature at the top of the appliance can be adjusted up and down by means of the “up and down” buttons. The temperature can be adjusted from 17 to 19°C

Temperature setting at the bottom of the appliance

Push SET2. Then the temperature at the bottom of the appliance can be adjusted up and down by means of the “up and down” buttons. The temperature can be adjusted from 7 to 9°C.

Advice

We advise you to put always a temperature gap of 10°C between the top and bottom of the appliance.

Alarm devices

There is a sub-alarm for the low-temperature sensor and an excess-alarm for the high-temperature sensor. 

The alarm consists of a beeper and a warning on the display.

Alarm for high temperature: beep sound + alternating display of “HtA” and actual temperature

Alarm for low temperature: beep sound + alternating display of “LtA” and actual temperature

The alarm temperature depends on the set points.

The beep sound can be cancelled by pushing a random thermostat button. Push the on/off button to erase the display alarm, first for cancelling the alarm, then again for restarting the compressor.

Light

To turn off the lights, press once 

Multi-zone storage

Typical serving temperature settings for the top and bottom sections are 17°C and 7°C respectively. With these settings, a suitable temperature gradient will be achieved in the cabinet for the storage of various types of wine distributed from top to bottom as follows:

- heavy red wines +16 to +19°C
- rosé and light red wines +12 to +16°C
- white wines +10 to +12°C
- champagne and sparkling wines +6 to +8°C

It is recommended that wine be served at a temperature which is a couple of degrees lower than the desired drinking temperature as the wine will be warmed slightly when it is poured into the glass.

Fault finding of V300SG2e multi zone wine cellar

Fault	Possible cause	Remedy
The appliance not working	The appliance is switched off. Power failure; the fuse is blown; the appliance is not plugged in correctly.	Press the on/off switch. Check that power is connected. Reset the fuse.
Water collects in the bottom of the cabinet.	The defrost water pipe is blocked.	Clean the defrost water channel and the drain hole on the rear wall of the cabinet.
Vibration or bothersome noise.	The appliance is not level. The appliance is resting against other kitchen elements. Containers or bottles inside the cabinet are rattling against one another.	Level the appliance using a spirit level. Move the appliance away from the kitchen elements or appliances it is in contact with. Move containers and/or bottles apart.
Compressor runs continuously.	High room temperature.	Ensure adequate ventilation.
P1 is shown on the display.	The upper sensor is disconnected or short-circuited.	Call for service. The temperature within the entire cabinet is maintained at the higher of the two setpoints until the fault has been corrected.
P2 is shown on the display.	The lower sensor is disconnected or short-circuited.	Call for service. The temperature within the entire cabinet is maintained at the higher of the two setpoints until the fault has been corrected.

Defrosting, cleaning and maintenance

Automatic defrosting

The wine cellar is defrosted automatically. Defrost water runs through a pipe and is collected in a tray above the compressor where the heat generated by the compressor causes it to evaporate. The defrost water tray should be cleaned at intervals.

Cleaning

Before cleaning the appliance, unplug it from the main supply. The cabinet is best cleaned using warm water (max. 65°C) with a little mild detergent. Never use cleaning agents that scour. Use a soft cloth. Rinse with clean water and dry thoroughly. The defrost water channel, in which condensation from the evaporator runs, is located at the bottom of the rear inside wall of the cabinet and must be kept clean. Add a few drops of disinfectant, e.g. Rodalon, to the defrost water drain a couple of times a year, and clean the drain using a pipe cleaner or similar. Never use sharp or pointed implements.

The sealing strip around the door must be cleaned regularly to prevent discolouration and prolong service life. Use clean water. After cleaning the sealing strip, check that it continues to provide a tight seal.

Dust collecting on the condenser on the rear of the cabinet, the compressor and in the compressor compartment is best removed using a vacuum cleaner.

Warranty, spare parts and service

Warranty disclaimer

Faults and damage caused directly or indirectly by incorrect operation, misuse, insufficient maintenance, incorrect building, installation or mains connection. Fire, accident, lightning, voltage variation or other electrical interference, including defective fuses or faults in mains installations.

Repairs performed by others than approved service centres and any other faults and damage that the manufacturer can substantiate are caused by reasons other than manufacturing or material faults are not covered by the warranty.

Please note that changes to the construction of the appliance or changes to the component equipment of the appliance will invalidate warranty and product liability, and the appliance cannot be used lawfully. The approval stated on rating plate will also be invalidated.

Transport damage discovered by the buyer is primarily a matter to be settled between the buyer and the distributor, i.e. the distributor must ensure that such complaints are resolved to the buyer's satisfaction.

Before calling for technical assistance, please check whether you are able to rectify the fault yourself. If your request for assistance is unwarranted, e.g. if the appliance has failed as a result of a blown fuse or incorrect operation, you will be charged the costs incurred by your call for technical assistance.

Spare parts

When ordering spare parts, please state the type, serial and product numbers of your appliance. This information is given on the rating plate. The rating plate contains various technical information, including type and serial number.

